

# tekmar® - Application

Boiler Control 262 & One Stage Setpoint Control 150

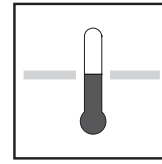
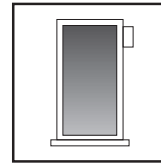

A 262-1

07/99

## Mechanical

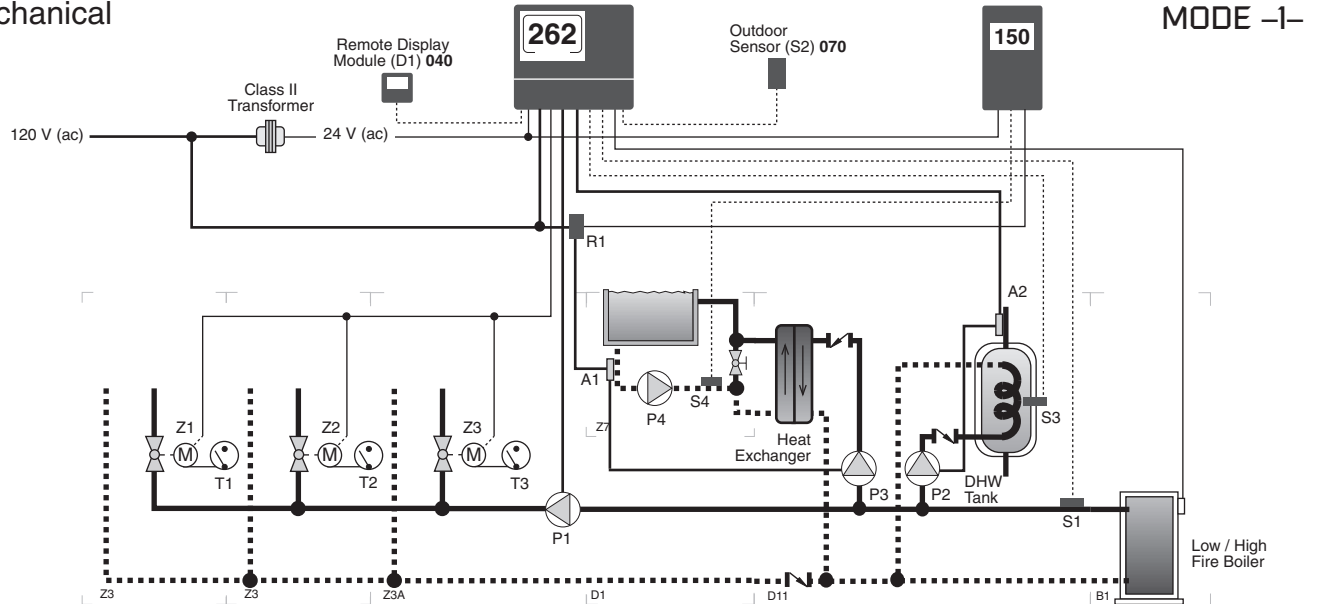

## Electrical

- A1 = Pool or Spa High Limit Aquastat
- A2 = DHW High Limit Aquastat
- D1 = Remote Display Module 040 (optional)
- P1 = Boiler Pump
- P2 = DHW Pump
- P3 = Pool or Spa Pump
- P4 = Pool or Spa Recirc. Pump
- R1 = Relay 003
- S1 = Boiler sensor 071
- S2 = Outdoor sensor 070
- S3 = DHW Sensor 071
- S4 = Pool or Spa Sensor 071
- T1, ..., T3 = Thermostats
- U1 = tekmar Timer 031 (optional)
- Z1, ..., Z3 = Zone Valve Motor End Switches

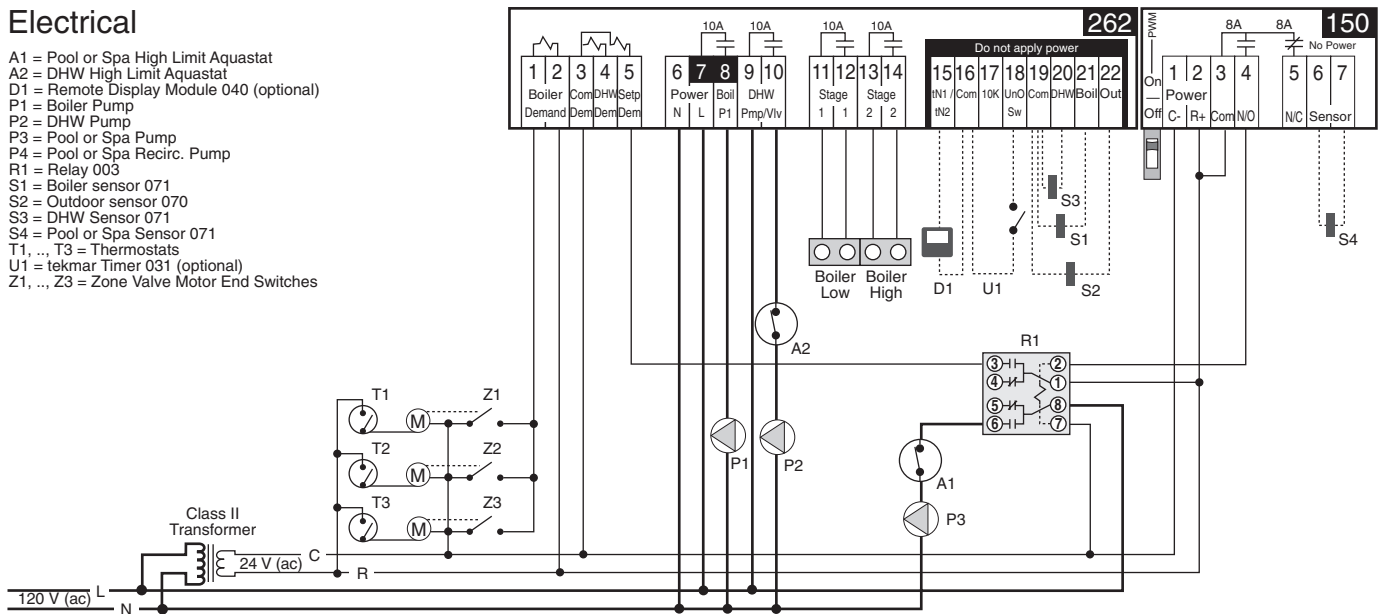

**Note:** This is only a concept drawing. The designer must determine whether this application will work in his system and must ensure compliance with code requirements. Necessary auxiliary equipment, isolation relays (for loads greater than the specified tekmar internal relay ratings), and other safety and limit devices must be added.

## System Operation

The Boiler Control 262 provides partial or full outdoor reset to three (or more) boiler zones. The Setpoint Control 150 controls the temperature of the pool or spa. The boiler is operated at the temperature required in order to satisfy the loads. The 262 also controls the supply of heat to an indirect Domestic Hot Water (DHW) tank. An optional Remote Display Module (RDM) provides remote adjustment and monitoring of the control.

**Heat Source Details** The heat source can be either a high mass or low mass non-condensing boiler or low temperature boiler. If using a low temperature boiler, refer to sections C3 and D1 of the Data Brochure for additional information.

**Piping Details** Thermostat controlled zone valves are piped into the boiler loop. The boiler pump (P1) provides circulation through these zones when heat is required. The pool or spa heat exchanger is piped into the boiler loop and the temperature is controlled through a pump (P3). Heat is supplied to the DHW tank through a DHW pump (P2).

**DHW Demand** When the DHW sensor (S3) calls for heat, the 262 turns on the DHW pump (P2) and raises the boiler water temperature to at least the DHW TANK setting plus 40°F (22°C). The control maintains the DHW tank temperature at the DHW TANK setting. The control can provide DHW priority (refer to sections C2 and C3 of the Data Brochure) by turning off the boiler pump (P1). Once the DHW demand is removed, the 262 performs a DHW Post Purge and possibly a Mixing Purge.

**Setpoint Demand** The Setpoint Control 150 cycles relay R1 in order to control the heat exchanger pump (P3) and maintain the pool or spa temperature. When the 150 requires heat, it provides a *Setpoint Demand* to the 262 through relay R1. The 262 increases the boiler temperature to at least the SETPOINT setting. The control can provide Setpoint priority (refer to sections C3 and D1 of the Data Brochure) by turning off the boiler pump (P1).

**Boiler Demand** When heat is required in the boiler zones, the zone valve end switches send a *Boiler Demand* to the 262. The 262 turns on the boiler pump (P1). The boiler supply water temperature is based on the *Reset Ratio* or *Characterized Heating Curve* settings. The boiler is staged to satisfy the required boiler supply water temperature. Whenever the boiler is fired, the 262 aims to increase the boiler temperature to at least the **Boil MIN** setting.

All control functions and specifications are listed in the Product Catalog I 000 and the Data Brochure D 262.

## Required Material and Essential Control Settings

### Required tekmar Products

- Boiler Control 262
- One Stage Setpoint Control 150
- Universal Sensor 071
- 1 x tekmar DPDT Relay 003

### Optional tekmar Products

- Remote Display Module (RDM) 040
- Timer 031

### 262 Essential Application Control Settings (Adjust Menu)

Item Field	Setting
MODE	-1-
STAGE 1	AUTO
STAGE 2	AUTO
DHW SENS	DHW
ROTATE	OFF

**Note** For all other settings, refer to the Data Brochure D 262 and D 150.

	tekmar Control Systems Ltd., Canada tekmar Control Systems, Inc., U.S.A. <b>Head Office: 5100 Silver Star Road</b> <b>Vernon, B.C. Canada V1B 3K4</b> Tel. (250) 545-7749 Fax. (250) 545-0650 Web Site: <a href="http://www.tekmarcontrols.com">www.tekmarcontrols.com</a>	
---	---	--

# tekmar® - Application

Boiler Control 262

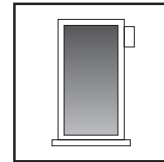

A 262-2

07/99

## Mechanical

MODE -1-

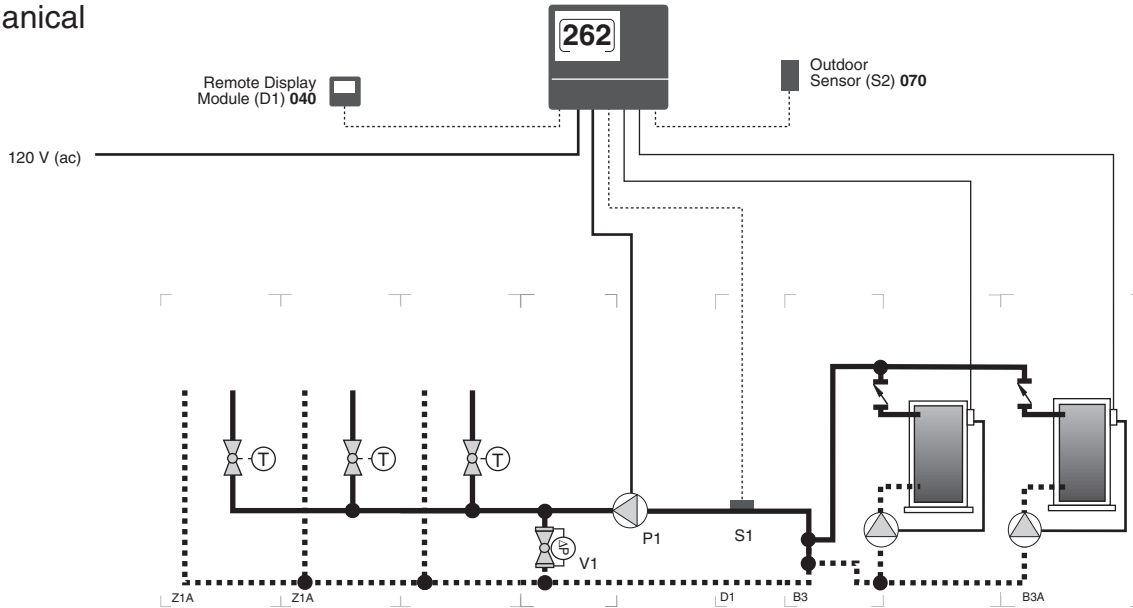

## Electrical

- D1 = Remote Display Module 040 (optional)
- P1 = Boiler Pump
- S1 = Boiler Sensor 071
- S2 = Outdoor Sensor 070
- T = Thermostatic Radiator Valve
- U1 = tekmar Timer 031 (optional)
- V1 = Balancing valve, globe valve, or pressure differential valve

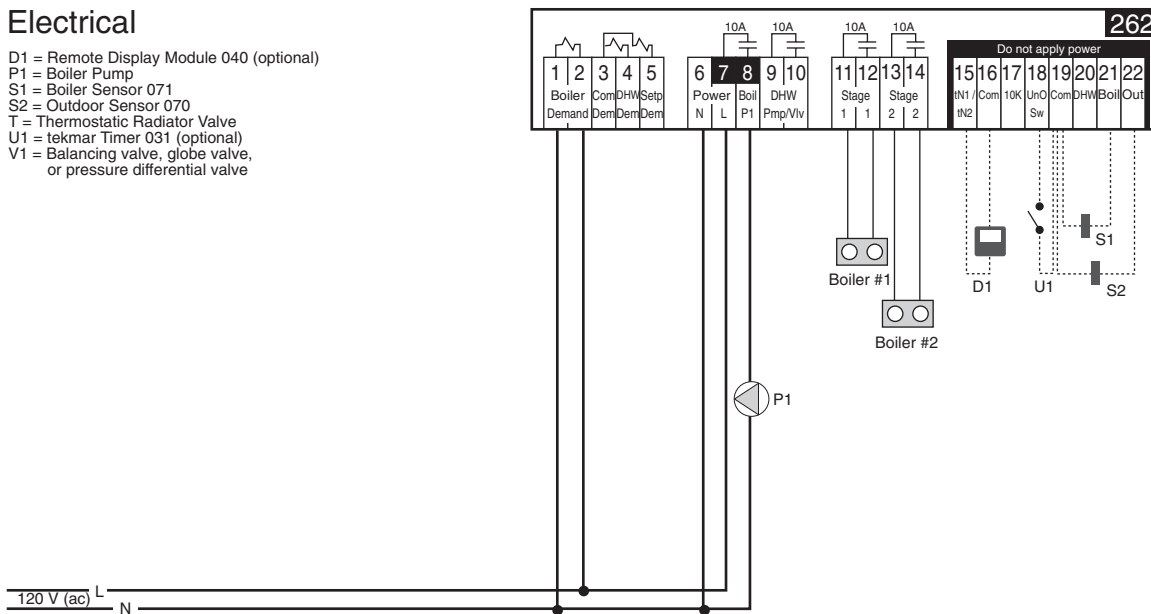

**Note:** This is only a concept drawing. The designer must determine whether this application will work in his system and must ensure compliance with code requirements. Necessary auxiliary equipment, isolation relays (for loads greater than the specified tekmar internal relay ratings), and other safety and limit devices must be added.

## System Operation

The Boiler Control 262 provides partial or full outdoor reset to three (or more) thermostatic radiator valve zones. Constant circulation to the zones is provided by the boiler pump (P1). The boilers are staged as required to provide the supply water temperature that satisfies the loads. An optional Remote Display Module (RDM) provides remote adjustment and monitoring of the control.

**Heat Source Details** The heat source can be either high mass or low mass non-condensing or low temperature boilers.

**Piping Details** Thermostatic radiator valve (TRV) zones are piped into the boiler loop. A pressure differential valve (V1) provides a bypass for the boiler pump (P1) in the event that most of the TRV's are closed. The boilers are piped using parallel primary / secondary in order to provide equal and isolated flow through each boiler.

**Boiler Demand** When the outdoor air temperature is below the Warm Weather Shut Down (WWSO) setting, the 262 turns on the boiler pump (P1). The boiler supply water temperature is based on the *Reset Ratio* or *Characterized Heating Curve* settings. The boilers are staged to satisfy the required boiler supply water temperature. Whenever the boilers are fired, the 262 aims to increase the boiler supply water temperature to at least the Boil MIN setting.

All control functions and specifications are listed in the Product Catalog I 000 and the Data Brochure D 262.

## Required Material and Essential Control Settings

### Required tekmar Products

Boiler Control 262

### Optional tekmar Products

Remote Display Module (RDM) 040  
Timer 031

### 262 Essential Application Control Settings (Adjust Menu)

Item Field	Setting
MODE	-1-
STAGE 1	AUTO
STAGE 2	AUTO

**Note** For all other settings, refer to the Data Brochure D 262.



tekmar Control Systems Ltd., Canada  
tekmar Control Systems, Inc., U.S.A.  
**Head Office: 5100 Silver Star Road**  
**Vernon, B.C. Canada V1B 3K4**  
Tel. (250) 545-7749 Fax. (250) 545-0650  
Web Site: [www.tekmarcontrols.com](http://www.tekmarcontrols.com)

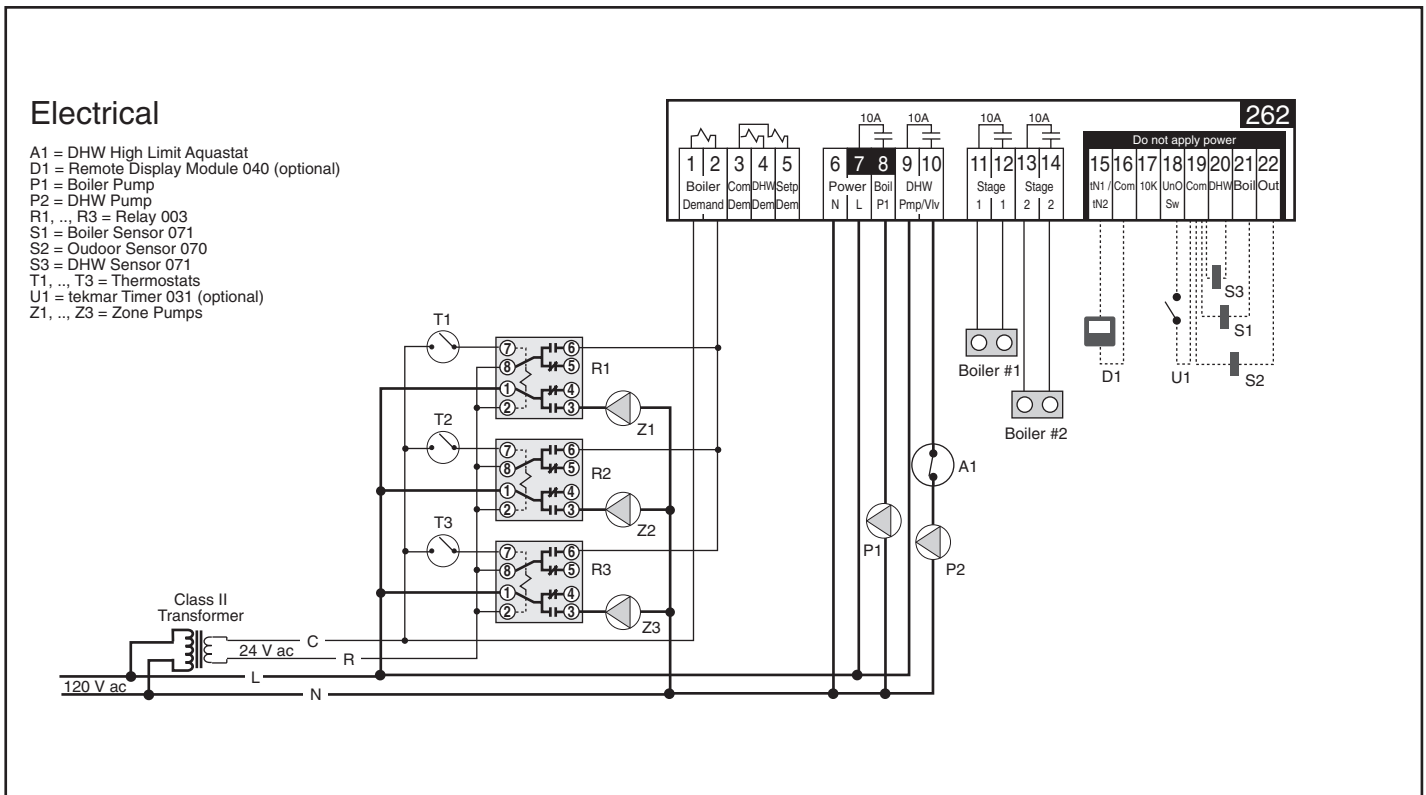
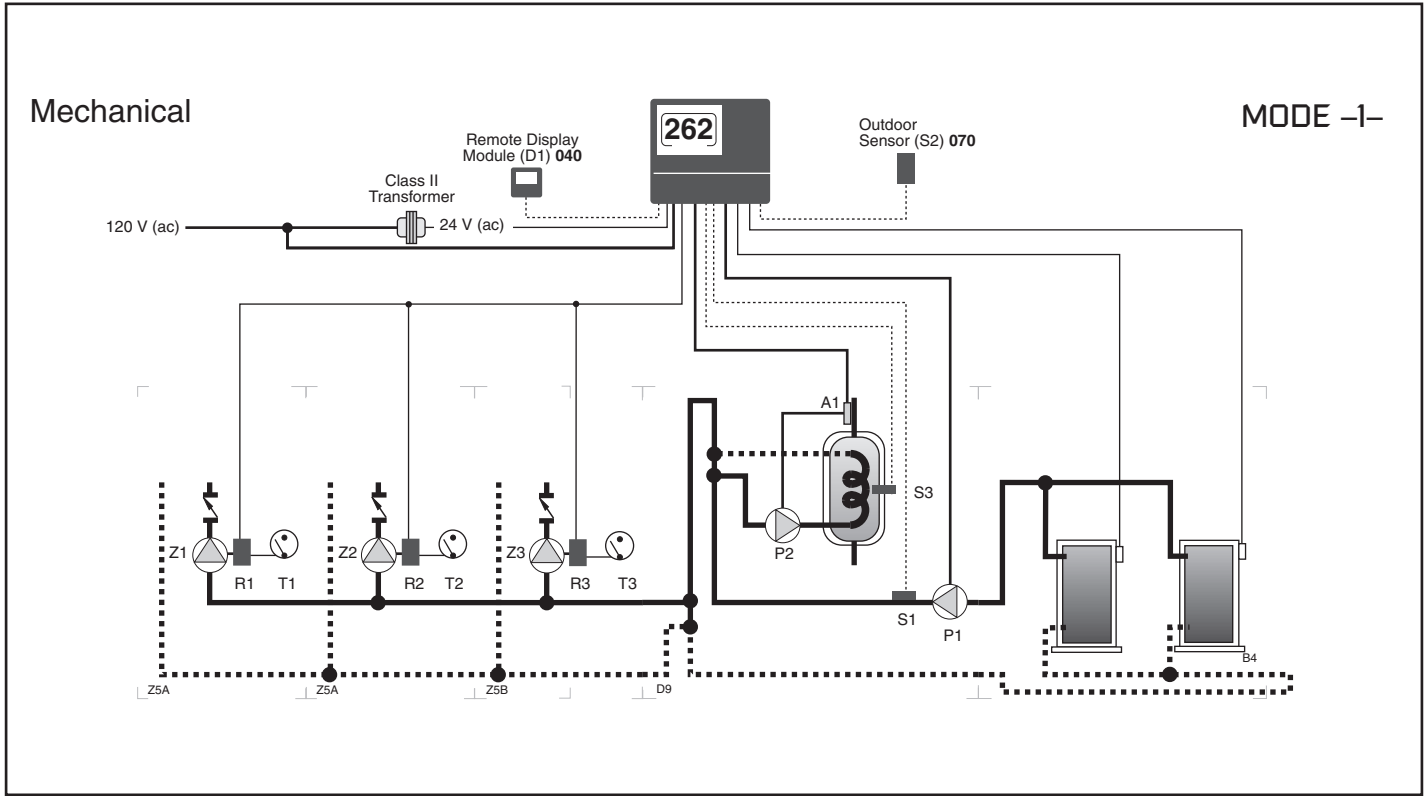
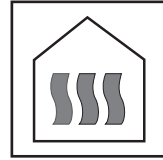

**Note:** This is only a concept drawing. The designer must determine whether this application will work in his system and must ensure compliance with code requirements. Necessary auxiliary equipment, isolation relays (for loads greater than the specified tekmar internal relay ratings), and other safety and limit devices must be added.

## System Operation

The Boiler Control 262 provides partial outdoor reset to three (or more) boiler zones. The 262 also controls the supply of heat to an indirect Domestic Hot Water (DHW) tank. The boilers are staged as required to provide the supply water temperature that satisfies the loads. An optional Remote Display Module (RDM) provides remote adjustment and monitoring of the control.

**Heat Source Details** The heat source can be either high mass or low mass non-condensing boilers.

**Piping Details** Thermostat controlled zone pumps are piped off the boiler loop as a secondary loop. Heat is supplied to the DHW tank through a DHW pump (P2). The boilers are piped in reverse return in order to ensure equal flow through both boilers. The boiler pump (P1) provides flow through the boilers and ensures flow past the DHW tank take-off and the zone pump take-off.

**DHW Demand** When the DHW sensor (S3) calls for heat, the 262 turns on the DHW pump (P2) and the boiler pump (P1) and raises the boiler water temperature to at least the DHW TANK setting plus 40°F (22°F). The control maintains the DHW tank at the DHW TANK setting. Once the DHW demand is removed, the 262 performs a DHW Post Purge and possibly a Mixing Purge.

**Boiler Demand** When heat is required in the heating zones, the zone pump relays send a Boiler Demand to the 262. The 262 turns on the boiler pump (P1). The boiler supply water temperature is based on the *Reset Ratio* or *Characterized Heating Curve* settings. The boilers are staged to satisfy the required boiler supply water temperature. Whenever the boilers are fired, the 262 aims to increase the boiler supply water temperature to at least the Boil MIN setting.

All control functions and specifications are listed in the Product Catalog I 000 and the Data Brochure D 262.

## Required Material and Essential Control Settings

### Required tekmar Products

Boiler Control 262  
3 x tekmar DPDT Relay 003

### Optional tekmar Products

Remote Display Module (RDM) 040  
Timer 031

### 262 Essential Application Control Settings (Adjust Menu)

Item Field	Setting
MODE	-1-
STAGE 1	AUTO
STAGE 2	AUTO
DHW THRU	VALV
DHW SENS	DHW

**Note** For all other settings, refer to the Data Brochure D 262.



tekmar Control Systems Ltd., Canada  
tekmar Control Systems, Inc., U.S.A.  
**Head Office: 5100 Silver Star Road**  
**Vernon, B.C. Canada V1B 3K4**  
**Tel. (250) 545-7749 Fax. (250) 545-0650**  
**Web Site: www.tekmarcontrols.com**

# tekmar® - Application

Boiler Control 262

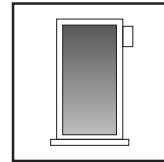

A 262-4

07/99

## Mechanical

MODE -2-

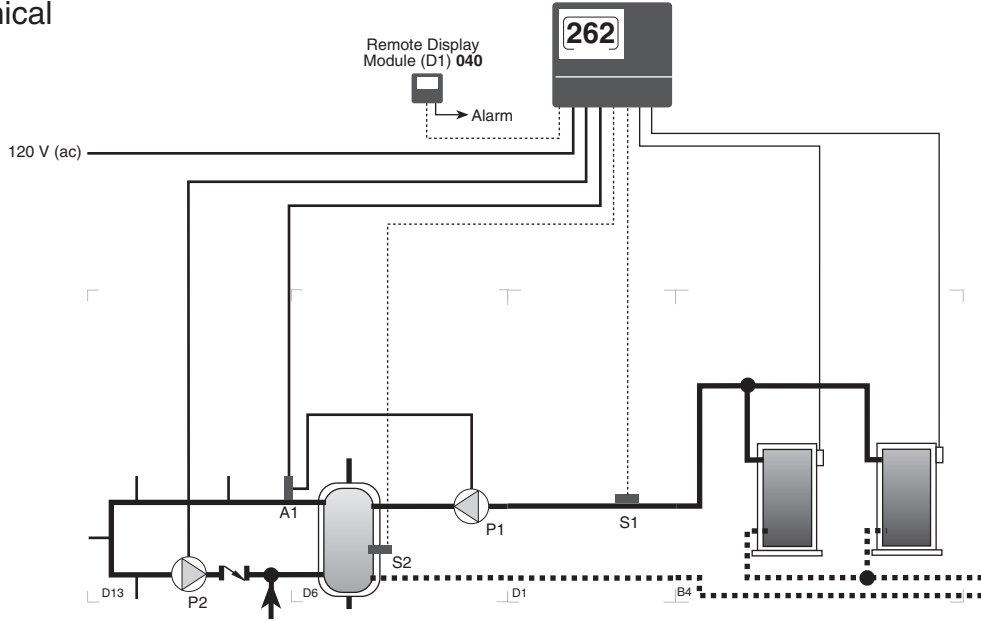

## Electrical

- A1 = DHW High Limit Aquastat (optional)
- D1 = Remote Display Module 040 (optional)
- P1 = Boiler Pump
- P2 = DHW Recirc. Pump
- S1 = Boiler Sensor 071
- S2 = DHW Sensor 071
- U1 = tekmar Timer 031 (optional)

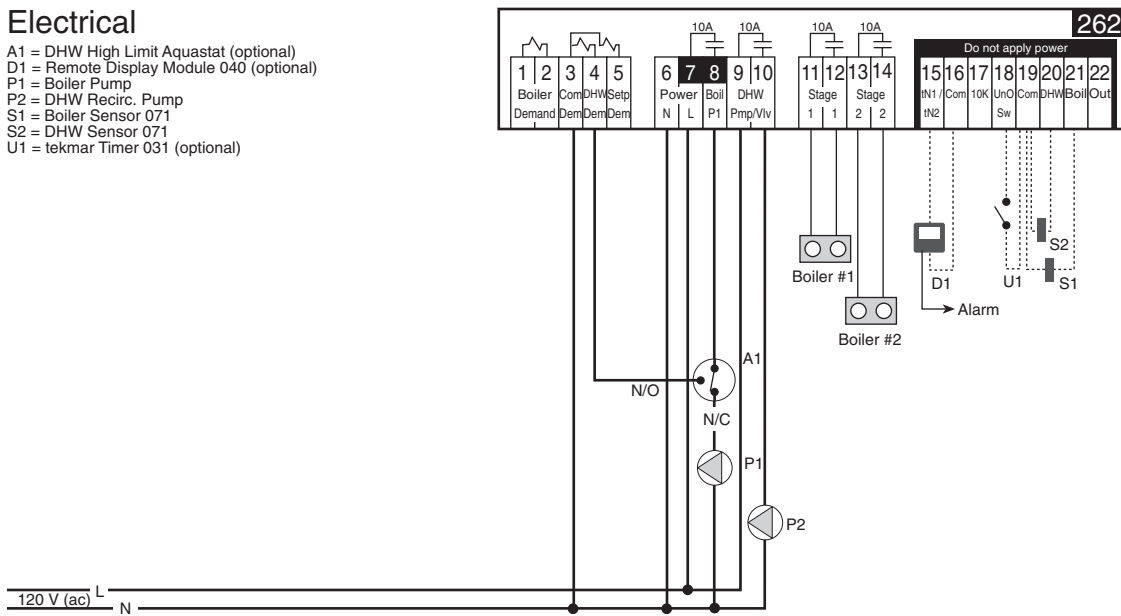

**Note:** This is only a concept drawing. The designer must determine whether this application will work in his system and must ensure compliance with code requirements. Necessary auxiliary equipment, isolation relays (for loads greater than the specified tekmar internal relay ratings), and other safety and limit devices must be added.

**System Operation**

The Boiler Control 262 provides control of two boilers for a dedicated Domestic Hot Water (DHW) storage system. An optional Remote Display Module (RDM) provides remote adjustment and monitoring of the control.

**Heat Source Details** The heat source can be high mass or low mass non-condensing or low temperature boilers or any boilers designed for this type of application.

**Piping Details** The boilers are piped in reverse return providing equal flow through each boiler. The DHW recirculation loop pump (P2) provides constant hot water flow past the fixtures.

**DHW Demand** When the DHW sensor (S2) calls for heat, the 262 turns on the boiler pump (P1) and raises the boiler water temperature to at least the DHW TANK setting plus 40°F (22°C). The control maintains the DHW tank temperature at the DHW TANK setting. The RDM is capable of sounding an alarm if the DHW tank overheats. When the DHW high limit aquastat (A1) is triggered, the 262 receives an external DHW Demand. When the 262 receives the demand, a DHW Error (DHW ERR) is registered and the alarm contact of the RDM is closed. To clear this error, refer to the Data Brochure D 262.

**Recirculation** The recirculation pump (P2) operates continuously when the control is in the Occupied mode. The recirculation pump (P2) is turned off when the control is in the UnOccupied mode.

All control functions and specifications are listed in the Product Catalog I 000 and the Data Brochure D 262.

**Required Material and Essential Control Settings**

**Required tekmar Products**

Boiler Control 262

**Optional tekmar Products**

Remote Display Module (RDM) 040  
Timer 031

**262 Essential Application Control Settings (Adjust Menu)**

<u>Item Field</u>	<u>Setting</u>
MODE	-2-
STAGE 1	AUTO
STAGE 2	AUTO
DHW SENS	DHW

**Note** For all other settings, refer to the Data Brochure D 262.

	<p>tekmar Control Systems Ltd., Canada tekmar Control Systems, Inc., U.S.A. <b>Head Office: 5100 Silver Star Road</b> <b>Vernon, B.C. Canada V1B 3K4</b> Tel. (250) 545-7749 Fax. (250) 545-0650 Web Site: <a href="http://www.tekmarcontrols.com">www.tekmarcontrols.com</a></p>	
---	---	--